

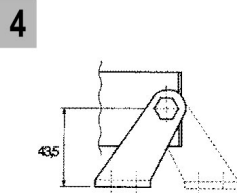

APRILINEARE DUO-TRY SYSTEM

OPERATOR DIMENSIONS

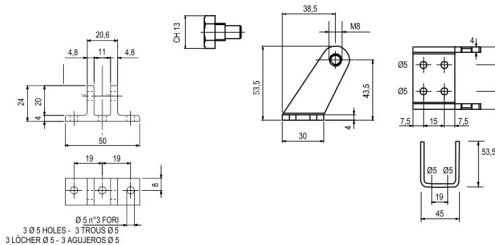
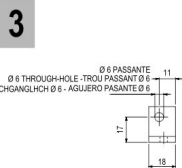
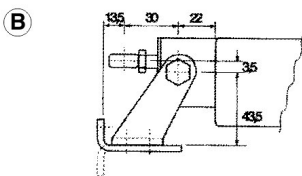
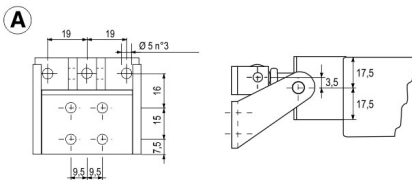
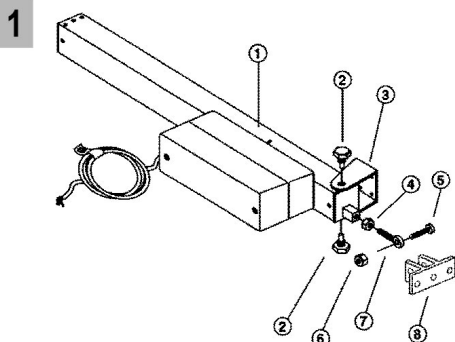
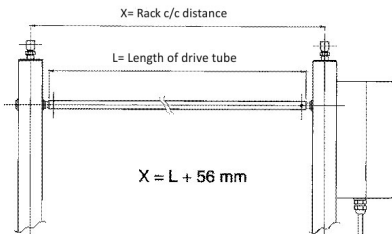

5 A

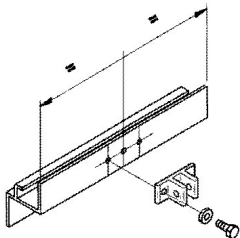

B

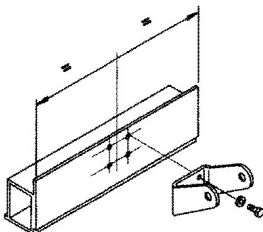

C

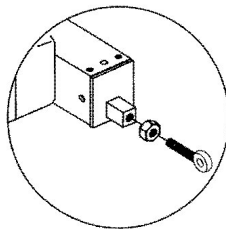

D

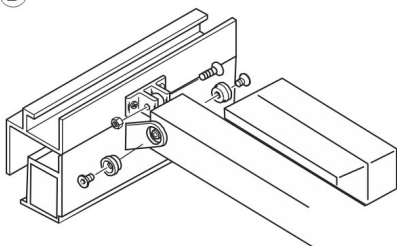

6 A

230 V

Neutro, Neutral, Neutre,
Mittelleiter, Neutro

230 V

Fase, Phase, Phase,
Phase, Fase

B 24 V

